

EURO SLIDING SERIES-29MM

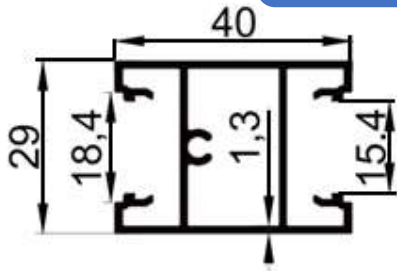

SL.NO.	SECTION NO.	WEIGHT(KG/M)
1	2701	0.650

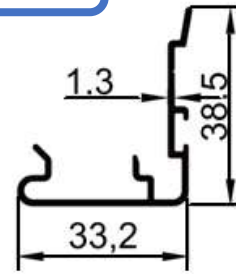

SL.NO.	SECTION NO.	WEIGHT(KG/M)
1	2710	0.358

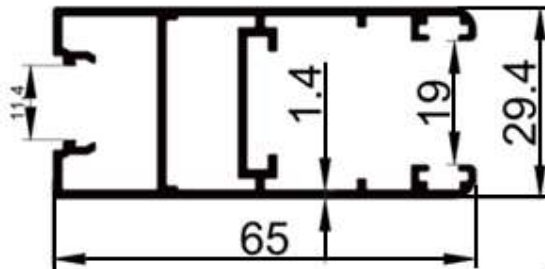

SL.NO.	SECTION NO.	WEIGHT(KG/M)
1	2711	0.925

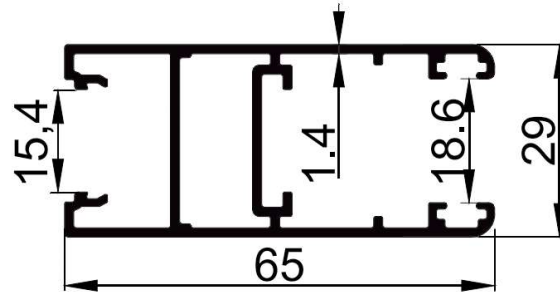

SL.NO.	SECTION NO.	WEIGHT(KG/M)
1	2712	0.903

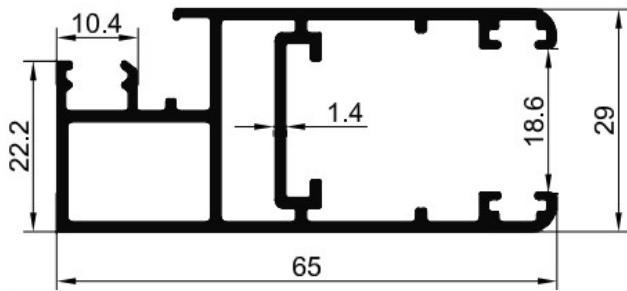

SL.NO.	SECTION NO.	WEIGHT(KG/M)
1	2713	0.943

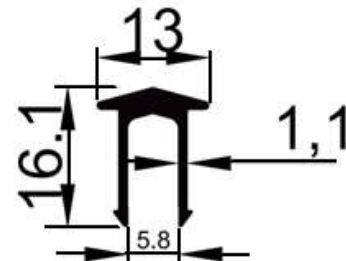

SL.NO.	SECTION NO.	WEIGHT(KG/M)
1	2714	0.157

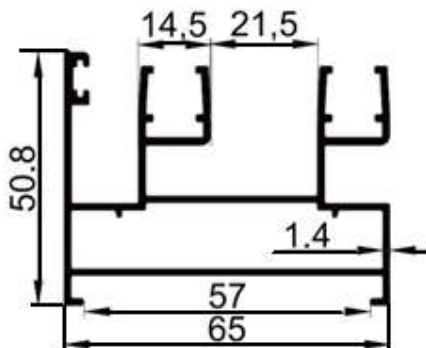

SL.NO.	SECTION NO.	WEIGHT(KG/M)
1	2715	1.314

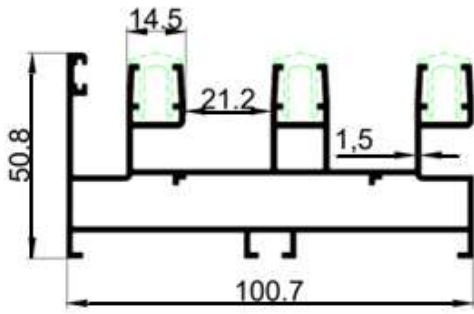

SL.NO.	SECTION NO.	WEIGHT(KG/M)
1	2716	1.946

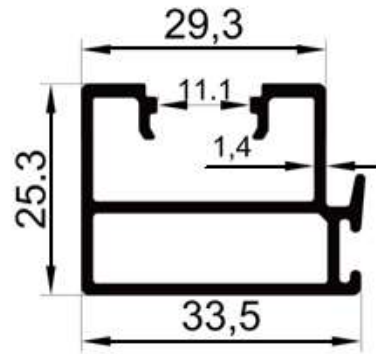

SL.NO.	SECTION NO.	WEIGHT(KG/M)
1	2717	0.553

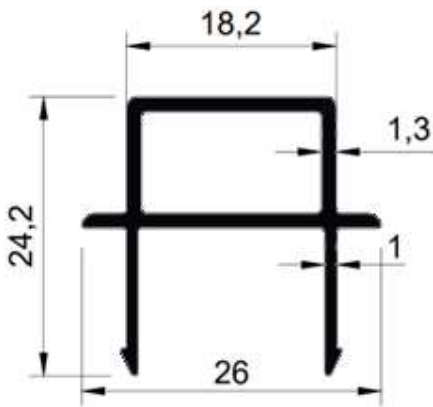

SL.NO.	SECTION NO.	WEIGHT(KG/M)
1	2697	0.284

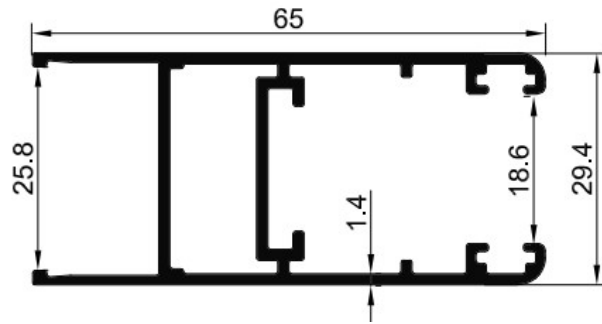

SL.NO.	SECTION NO.	WEIGHT(KG/M)
1	3011	0.818

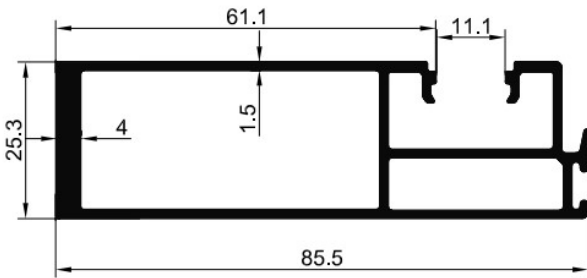

SL.NO.	SECTION NO.	WEIGHT(KG/M)
1	3013	1.215

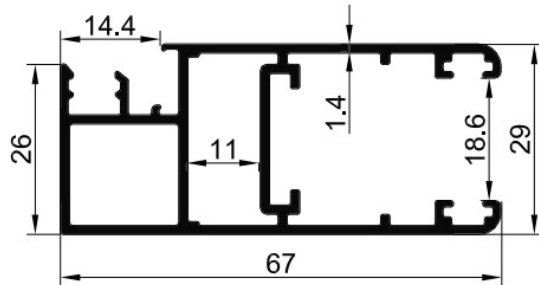

SL.NO.	SECTION NO.	WEIGHT(KG/M)
1	2934	0.965